

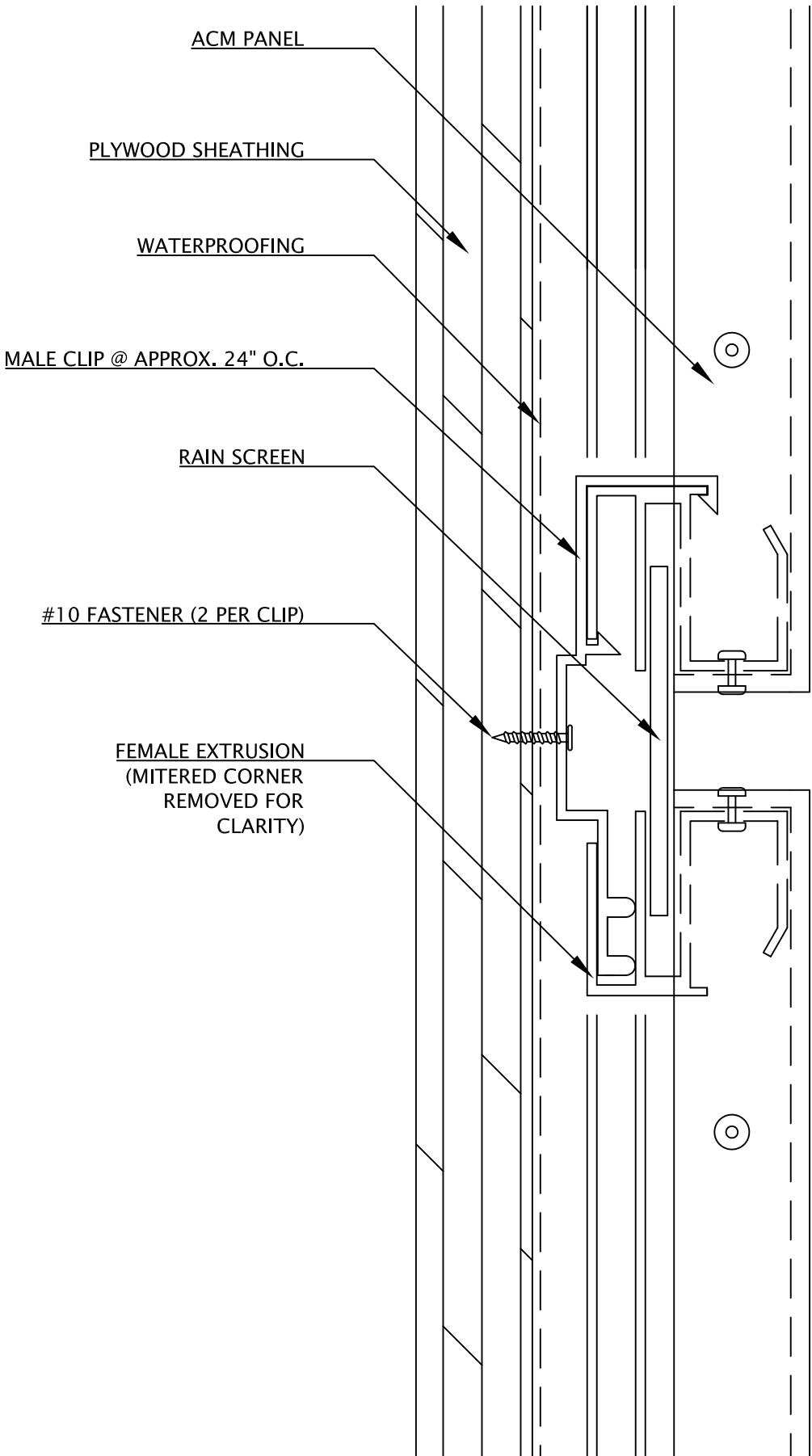

TEXAS ACM
Aluminum Composite Panels

PROJECT:	TXACM-RS TYPICAL DETAILS
TITLE:	VERTICAL JOINT
SCALE:	N.T.S

DATE: APRIL 17, 2017

16809 RADHOLME COURT
ROUND ROCK, TX 78664
512.466.1181
512.252.8923 FAX
texasacm3@gmail.com
www.texasacm.net



PROJECT:	TXACM-RS TYPICAL DETAILS	DATE:	APRIL 17, 2017
TITLE:	HORIZONTAL JOINT	16809 RADHOLME COURT ROUND ROCK, TX 78664 512.466.1181	
SCALE:	N.T.S.	512.252.8923 FAX texasacm3@gmail.com www.texasacm.net	

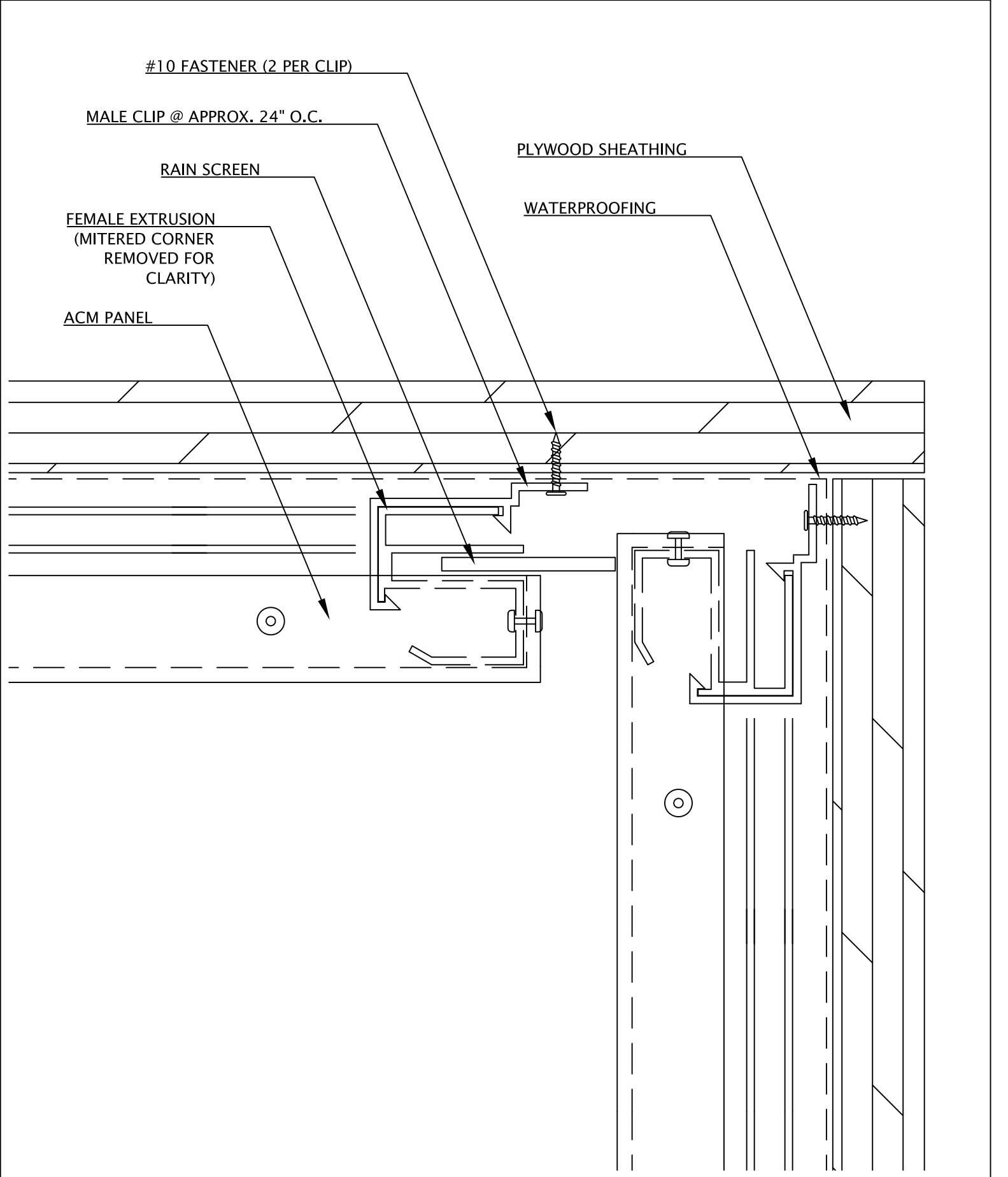

#10 FASTENER (2 PER CLIP)

MALE CLIP @ APPROX. 24" O.C.

RAIN SCREEN

PLYWOOD SHEATHING

FEMALE EXTRUSION
(MITERED CORNER
REMOVED FOR
CLARITY)

WATERPROOFING

ACM PANEL

 <p>TEXAS ACM Aluminum Composite Panels</p>	<p>PROJECT: TXACM-RS TYPICAL DETAILS</p>	<p>DATE: APRIL 17, 2017</p>
	<p>TITLE: INSIDE CORNER</p>	<p>16809 RADHOLME COURT ROUND ROCK, TX 78664 512.466.1181 512.252.8923 FAX texasacm3@gmail.com www.texasacm.net</p>
	<p>SCALE: N.T.S</p>	

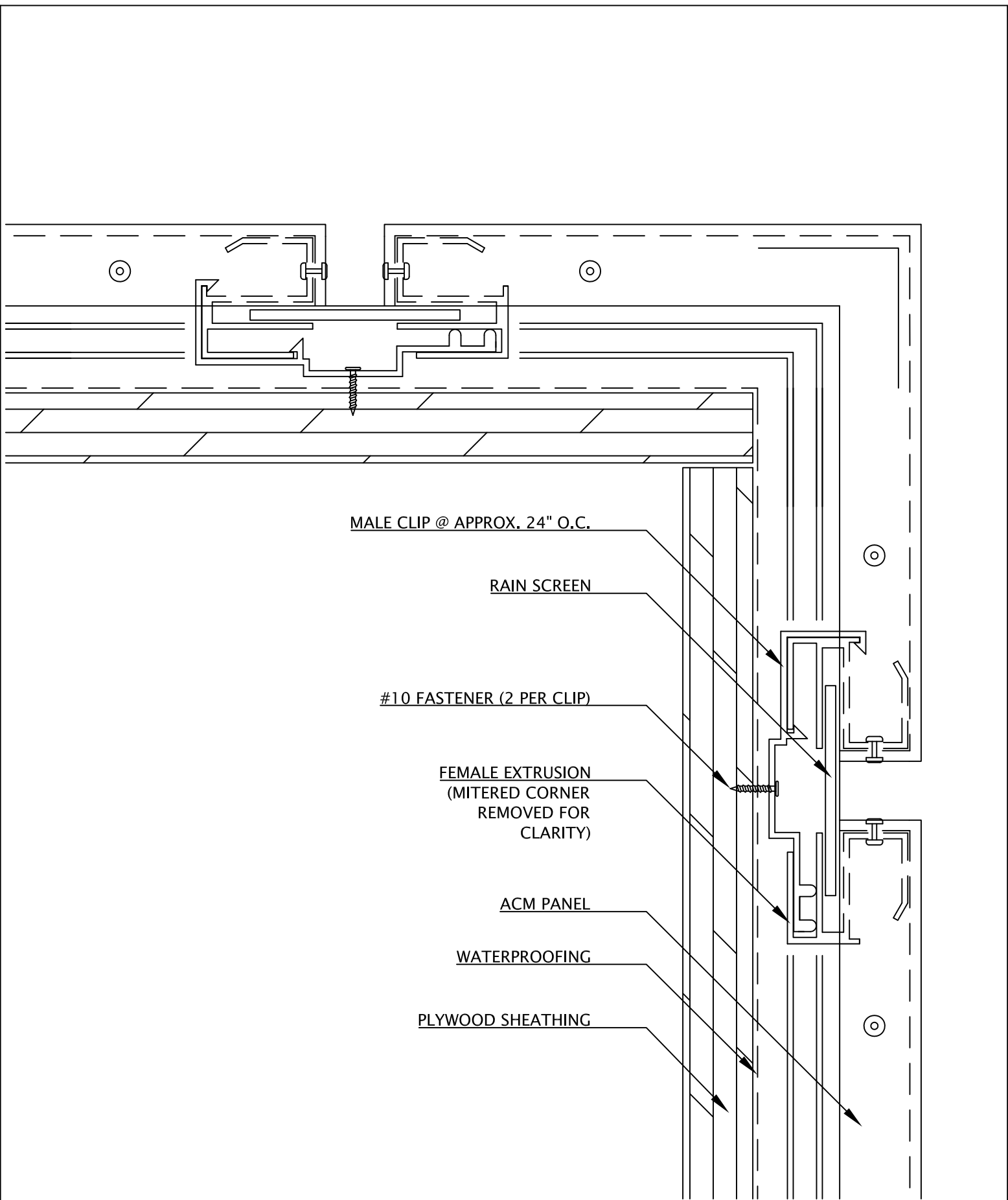

MALE CLIP @ APPROX. 24" O.C.

RAIN SCREEN

#10 FASTENER (2 PER CLIP)

FEMALE EXTRUSION
(MITERED CORNER
REMOVED FOR
CLARITY)

ACM PANEL

WATERPROOFING

PLYWOOD SHEATHING



TEXAS ACM
Aluminum Composite Panels

PROJECT:	TXACM-RS TYPICAL DETAILS
TITLE:	OUTSIDE CORNER
SCALE:	N.T.S

DATE:	APRIL 17, 2017
16809 RADHOLME COURT ROUND ROCK, TX 78664 512.466.1181 512.252.8923 FAX texasacm3@gmail.com www.texasacm.net	

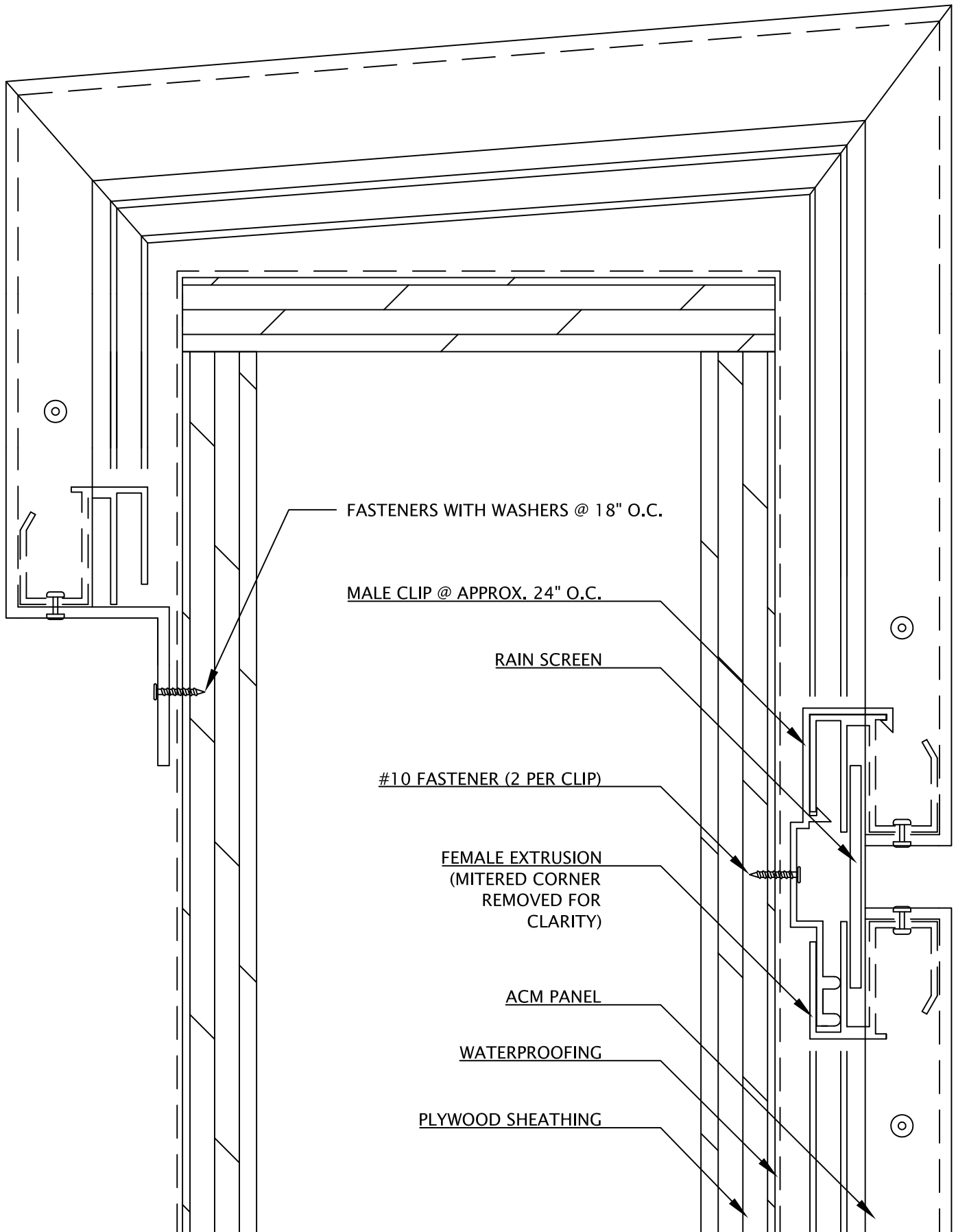

TEXAS ACM
Aluminum Composite Panels

PROJECT:	TXACM-RS TYPICAL DETAILS	DATE:	APRIL 17, 2017
TITLE:	COPING	16809 RADHOLME COURT ROUND ROCK, TX 78664 512.466.1181	
SCALE:	N.T.S.	512.252.8923 FAX texasacm3@gmail.com www.texasacm.net	

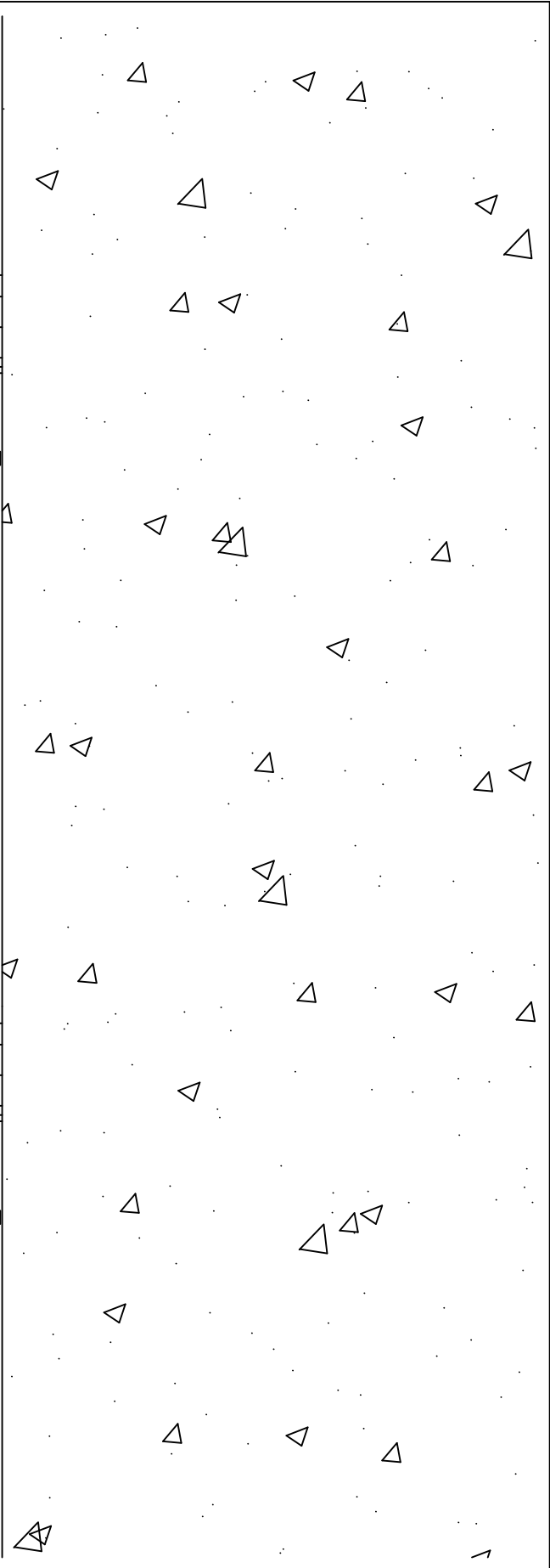
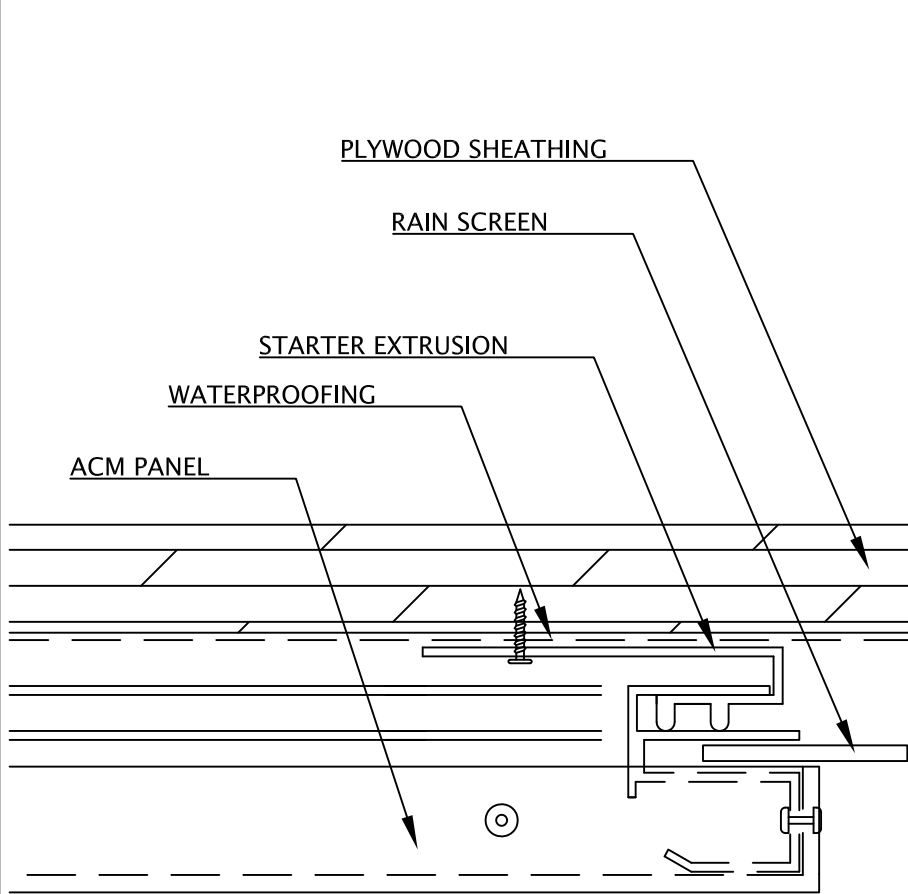
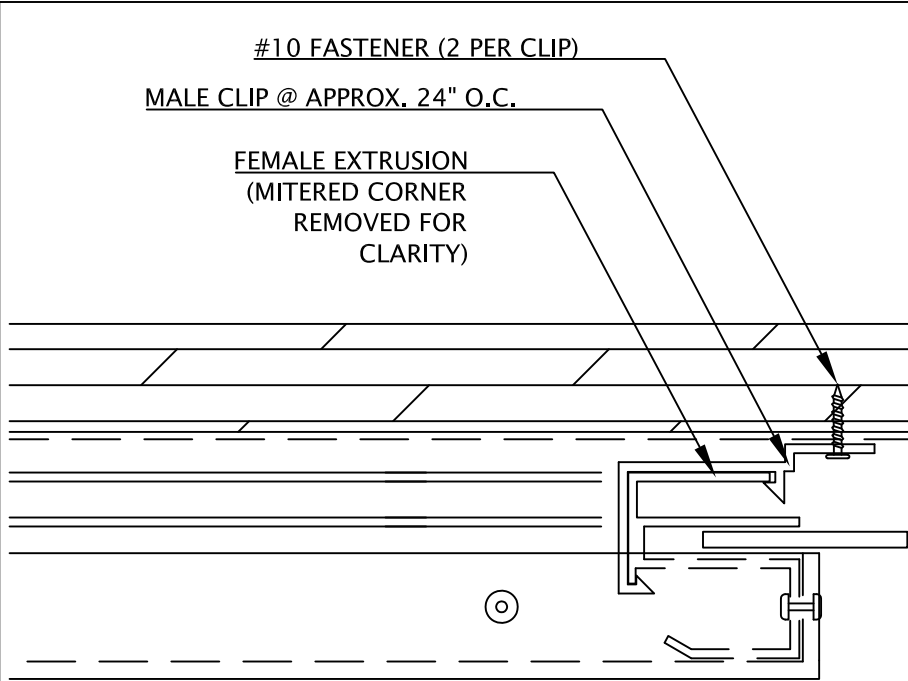



TEXAS ACM
Aluminum Composite Panels

PROJECT:	TXACM-RS TYPICAL DETAILS
TITLE:	END WALL
SCALE:	N.T.S

DATE: APRIL 17, 2017

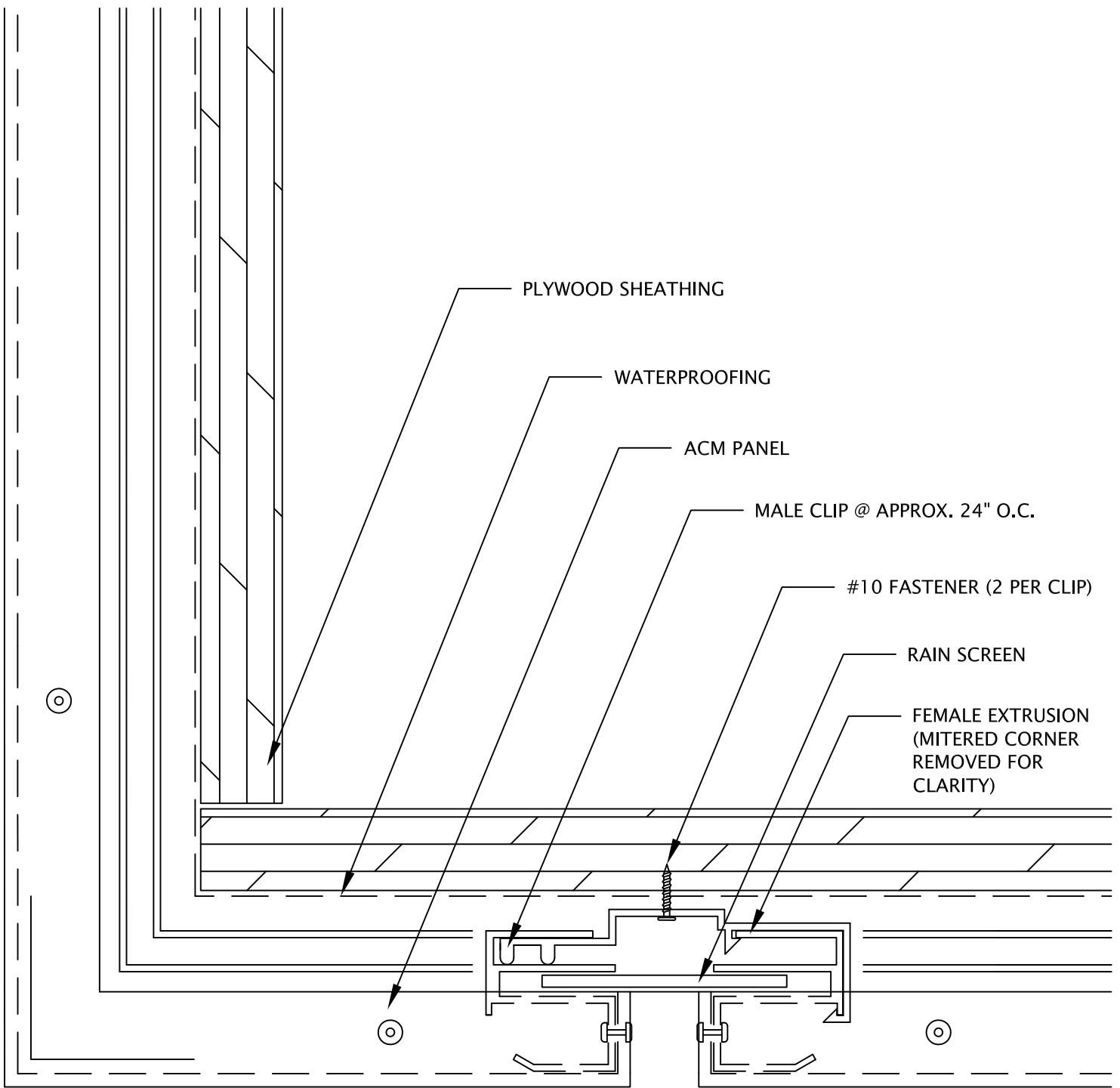
16809 RADHOLME COURT
ROUND ROCK, TX 78664
512.466.1181
512.252.8923 FAX
texasacm3@gmail.com
www.texasacm.net



TEXAS ACM
Aluminum Composite Panels

PROJECT:	TXACM-RS TYPICAL DETAILS	DATE:	APRIL 17, 2017
TITLE:	FASCIA SOFFIT	16809 RADHOLME COURT ROUND ROCK, TX 78664 512.466.1181 512.252.8923 FAX texasacm3@gmail.com www.texasacm.net	
SCALE:	N.T.S.		

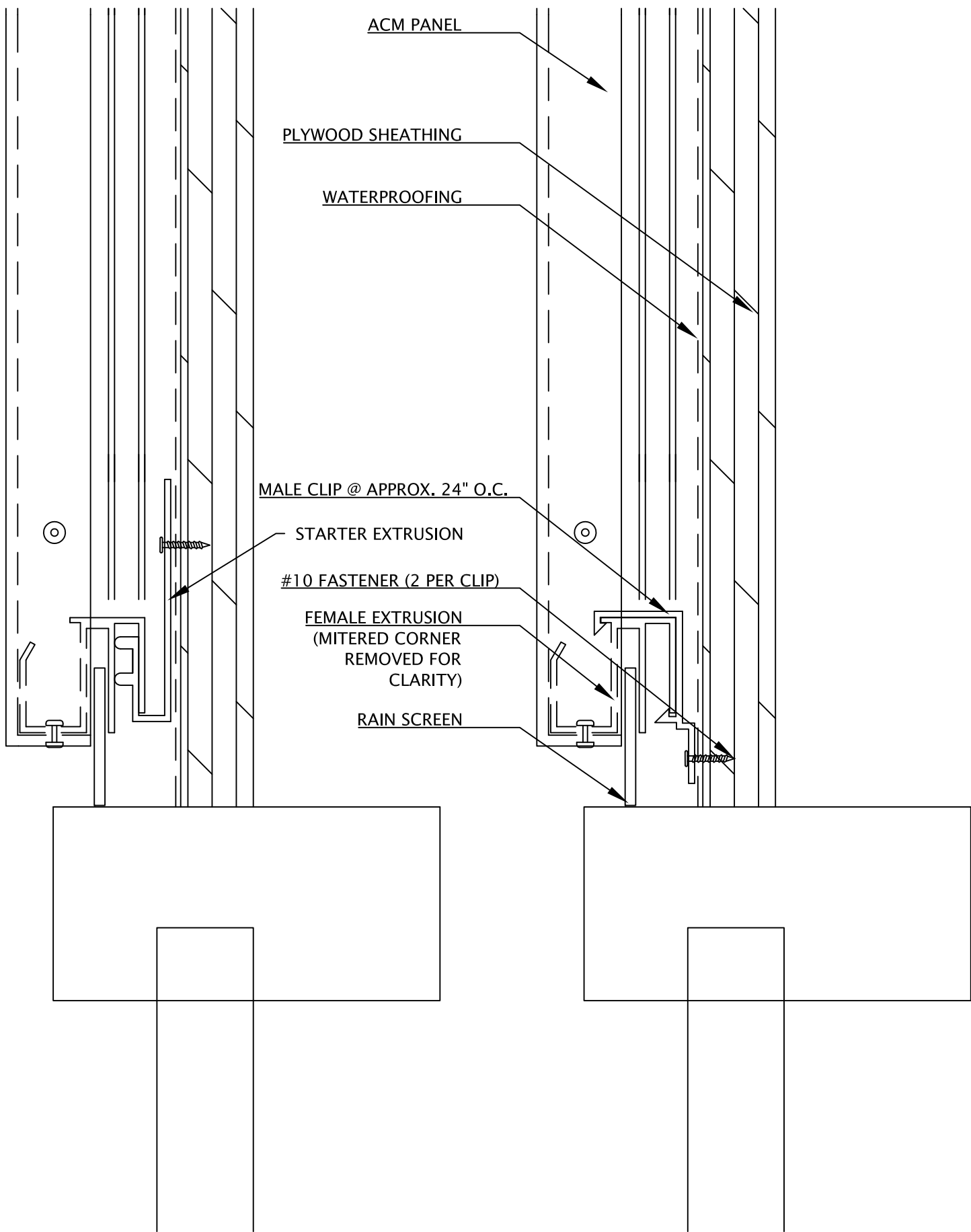

TEXAS ACM
Aluminum Composite Panels

PROJECT:	TXACM-RS TYPICAL DETAILS	DATE:	APRIL 17, 2017
TITLE:	HEAD	16809 RADHOLME COURT ROUND ROCK, TX 78664 512.466.1181 512.252.8923 FAX texasacm3@gmail.com www.texasacm.net	
SCALE:	N.T.S.		

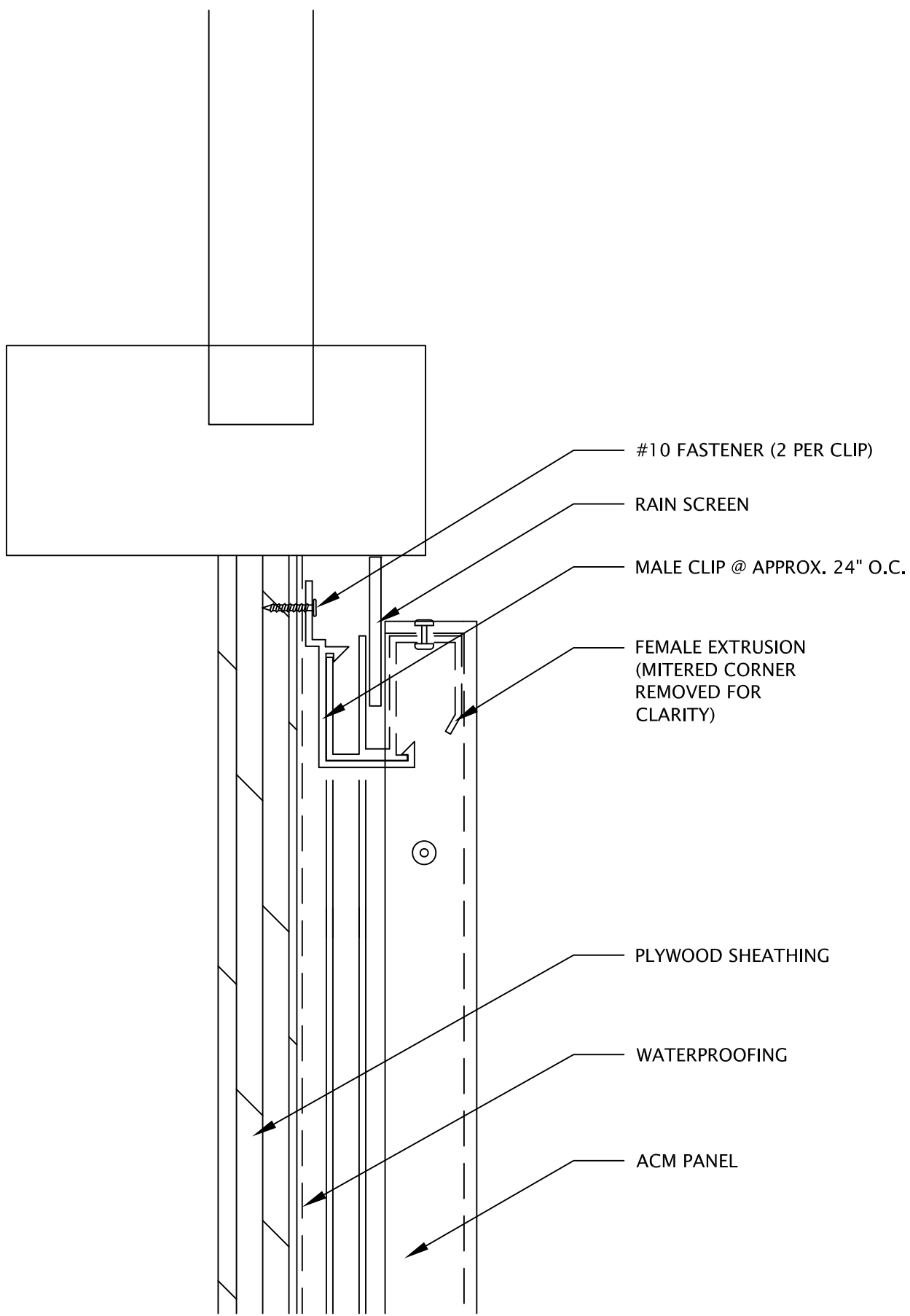

TEXAS ACM
Aluminum Composite Panels

PROJECT:	TXACM-RS TYPICAL DETAILS	DATE:	APRIL 17, 2017
TITLE:	SILL	16809 RADHOLME COURT ROUND ROCK, TX 78664 512.466.1181 512.252.8923 FAX texasacm3@gmail.com www.texasacm.net	
SCALE:	N.T.S		



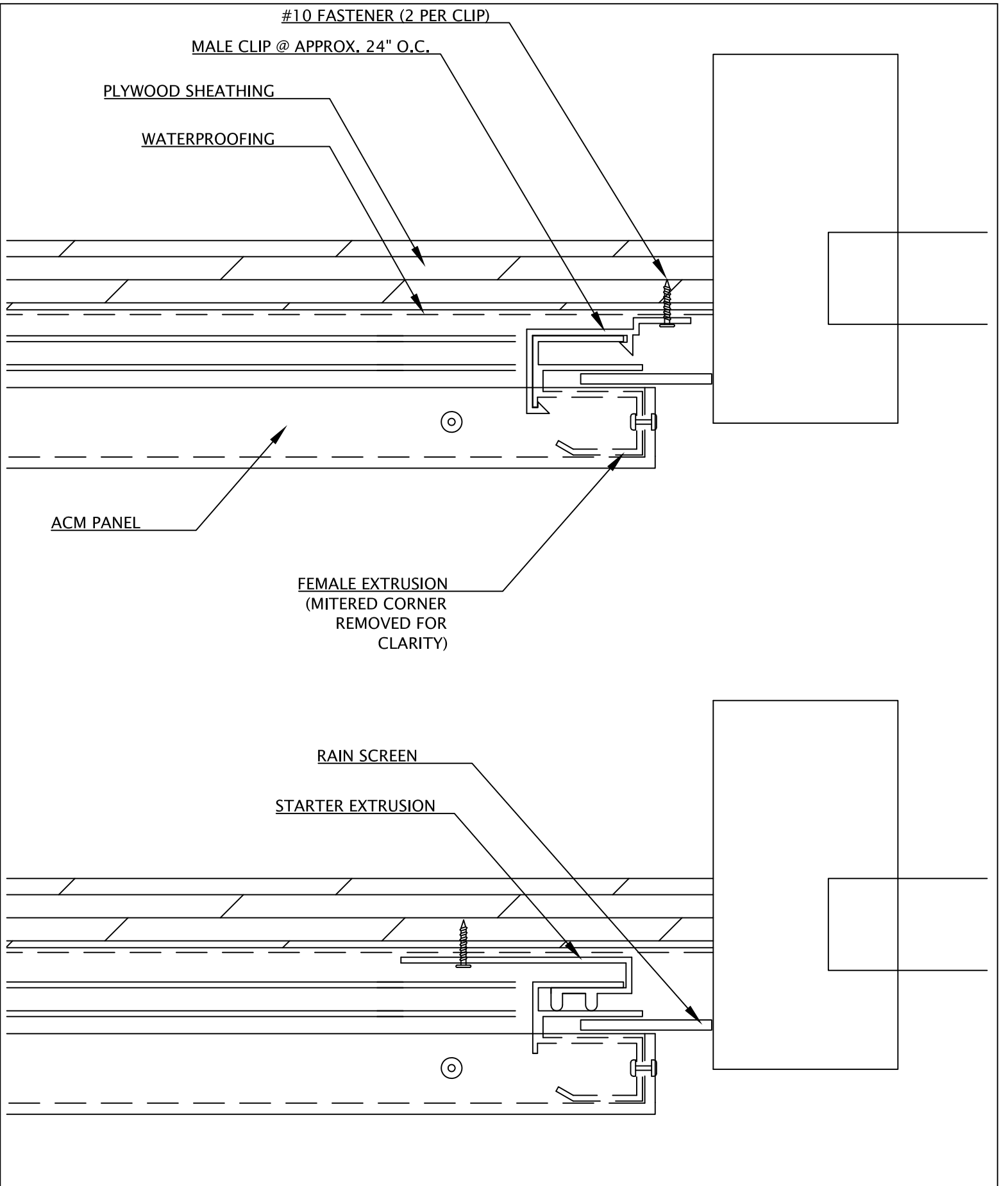

PROJECT:	TXACM-RS TYPICAL DETAILS
TITLE:	JAMB
SCALE:	N.T.S

DATE:	APRIL 17, 2017
16809 RADHOLME COURT ROUND ROCK, TX 78664 512.466.1181 512.252.8923 FAX texasacm3@gmail.com www.texasacm.net	